

VKA/VKAS

VKA



VKAS



Circular duct fans

Apvalūs kanaliniai ventilatoriai

Wentylatory do kanałów okrągłych

Круглые канальные вентиляторы



VKA

Circular duct fans are used for air supply or extract in ventilation and air conditioning systems. Are mounted into a system of round air ducts. Can be installed in any position. Not suitable for polluted air, aggressive and explosive gases.

Impeller with backward curved blades.

Motor: external rotor, motor protection with built-in thermal-contact, maintenance free ball bearings.

Mounting bracket LAV including.

VKAS

Circular duct fans used for air extract in ventilation and air conditioning systems. Are mounted on the walls. Not suitable for polluted air, aggressive and explosive gases.

VKA/VKAS with powder coating finishing RAL 7035.



VKA

Kanaliniai ventilatoriai, skirti vėdinimo ir oro kondicionavimo sistemoms, montuojami į apvalių ortakių sistemą. Naudojami oro tiekimui ir šalinimui. Nenaudojami užteršto oro, agresyvių, sprogių dujų transportavimui.

Sparnuotė: atgal lenktais sparneliais, plastmasinė arba cinkuoto plieno.

Variklis: išorinis rotorius, tiesioginė pavara, integruota termokontaktinė variklio apsauga, ilgai tarnaujantys, nereikalaujantys priežiūros guoliai.

Komplektuojamas su laikikliu LAV.

VKA/VKAS 100-315 korpusas: dažytas RAL 7035 miltelinio būdu.

VKAS

Kanaliniai ventilatoriai skirti vėdinimo ir oro kondicionavimo sistemoms, montuojami ant sienos. Naudojami oro tiekimui ir šalinimui.

Nenaudojami užteršto oro, agresyvių, sprogių dujų transportavimui.



VKA

Okrągłe wentylatory stosowane są do nawiewu i wyciągu powietrza w wentylacji i klimatyzacji. Montowane w układzie okrągłych kanałów wentylacyjnych. Mogą być instalowane w dowolnej pozycji. Nie nadają się do zastosowań w środowiskach agresywnych chemicznie oraz zagrożonych wybuchem. Nie zaleca się stosować w instalacjach zanieczyszczonych cząstkami stałymi, pyłami i odpadami technologicznymi.

Nie stosować w instalacjach oddymiania, przeciwpożarowych, spalinyowych. Wirnik z łopatkami pochylonymi do tyłu. Silnik z wirnikiem zewnętrznym oraz z wbudowanym termicznym zabezpieczeniem, bezobsługowe łożyska kulkowe. LAV wspornik montażowy w komplecie.

VKAS

Zastosowanie: jak wentylatory VKA. Przystosowane do montażu w ścianach.



VKA

Канальные вентиляторы для систем вентиляции и кондиционирования, устанавливаются в систему круглых воздуховодов. Эксплуатируются в целях подачи и вытяжки воздуха. Не используются при транспортировке загрязнённого воздуха, агрессивных, взрывоопасных газов.

Крыльчатка: загнутые назад лопатки.

Двигатель: наружный ротор, прямая передача, встроенная термомоконтактная защита двигателя, не требующие ухода подшипники с длительным сроком службы.

Прилагается монтажный кронштейн LAV.

VKAS

Канальные вентиляторы для систем вентиляции и кондиционирования, настенные. Эксплуатируются в целях подачи и вытяжки воздуха. Не используются при транспортировке загрязнённого воздуха, агрессивных, взрывоопасных газов.

VKA/VKAS окрашенный RAL 7035.

Accessories

Single phase speed controller



TGRV

p. 138

Single phase speed controller



ETY

p. 141

Mounting clamp



AP

p. 152

Guard grille



AGO

p. 212

Back draft shutter



RSK

p. 205

Circular duct silencer



AKS

p. 198

VKA

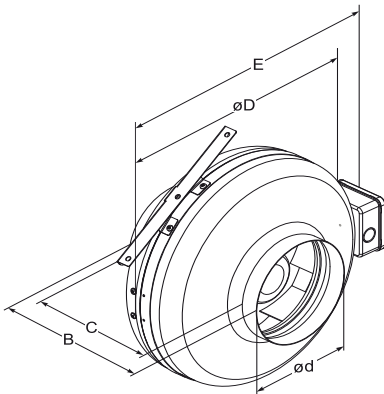

LAV

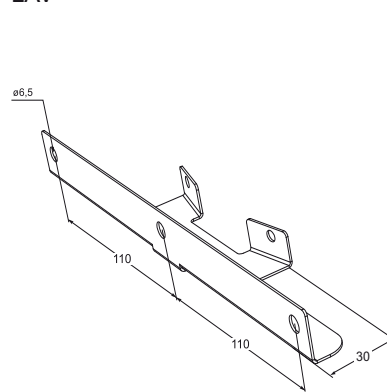

VKAS

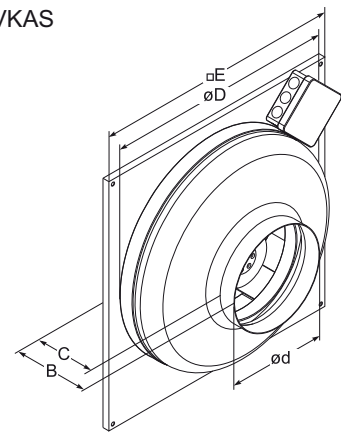

VKA

Type	Dimensions [mm]				
	B	C	øD	ød	E
VKA 100 MD/LD	206±2	167±2	245	100	290
VKA 125 MD/LD	206±2	175±2	245	125	290
VKA 150 LD	227±2	176±2	345	150	390
VKA 160 MD	202±2	153±2	245	160	290
VKA 160 LD	227±2	176±2	345	160	390
VKA 200 MD	219±2	167±2	345	200	390
VKA 200 LD	227±2	175±2	345	200	390
VKA 250 MD	223±2	163±2	345	250	390
VKA 250 LD	230±2	170±2	345	250	390
VKA 315 MD	247±2	179±2	400	315	445
VKA 315 LD	257±2	189±2	400	315	445

VKAS

Type	Dimensions [mm]				
	B	C	øD	ød	□E
VKAS 100 MD/LD	122	103	242	100	310
VKAS 125 MD/LD	116	101	242	125	310
VKAS 150 LD	129	104	342	150	400
VKAS 160 MD	116	92	242	160	310
VKAS 160 LD	129	104	342	160	400
VKAS 200 MD	123	99	342	200	400
VKAS 200 LD	131	107	342	200	400
VKAS 250 MD	125	100	342	250	400
VKAS 250 LD	131	106	342	250	400
VKAS 315 MD	156	116	400	315	460
VKAS 315 LD	166	126	400	315	460

Type	Accessories										
	TGRV	ETY	AP	AGO	RSK	AKS	FD	FDI	EKA	AVS	AVA
VKA/VKAS 100 MD/LD	1,5	1,5	100	100	100	100	100	100	100	100	100
VKA/VKAS 125 MD/LD	1,5	1,5	125	125	125	125	125	125	125	125	125
VKA/VKAS 150 LD	1,5	1,5	150	150	150	150	-	-	-	-	-
VKA/VKAS 160 MD	1,5	1,5	160	160	160	160	160	160	160	160	160
VKA/VKAS 160 LD	1,5	1,5	160	160	160	160	160	160	160	160	160
VKA/VKAS 200 MD	1,5	1,5	200	200	200	200	200	200	200	200	200
VKA/VKAS 200 LD	1,5	1,5	200	200	200	200	200	200	200	200	200
VKA/VKAS 250 MD	1,5	1,5	250	250	250	250	250	250	250	250	250
VKA/VKAS 250 LD	1,5	1,5	250	250	250	250	250	250	250	250	250
VKA/VKAS 315 MD	1,5	1,5	315	315	315	315	315	315	315	315	315
VKA/VKAS 315 LD	1,5	1,5	315	315	315	315	315	315	315	315	315

Accessories

Filter cassette



Filter cassette



Electric duct heater



Heating coil



Duct water cooler



VKA/VKAS

VKA 100 MD

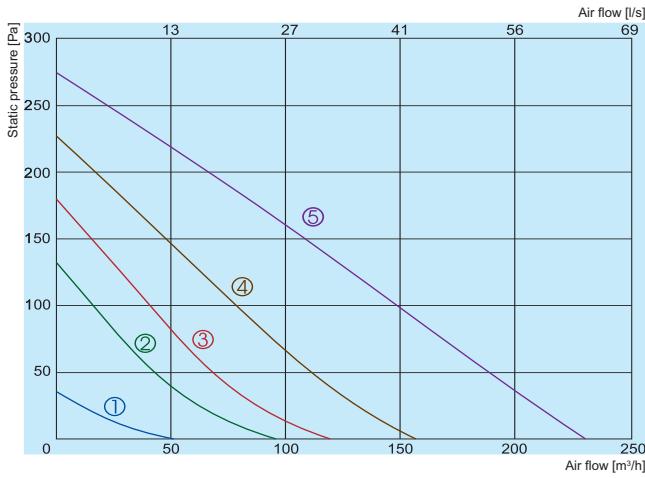

- ① 80V
- ② 120V
- ③ 140V
- ④ 170V
- ⑤ 230V

100 MD

In duct
Surrounding

LWA total, dB(A)	Lwa, dB(A)						
	125 Hz	250 Hz	500 Hz	1 kHz	2 kHz	4 kHz	8 kHz
In duct	61	43	58	51	55	50	39
Surrounding	46	24	25	35	44	41	28

Measured at 203 m³/h, 32 Pa

VKA 100 LD

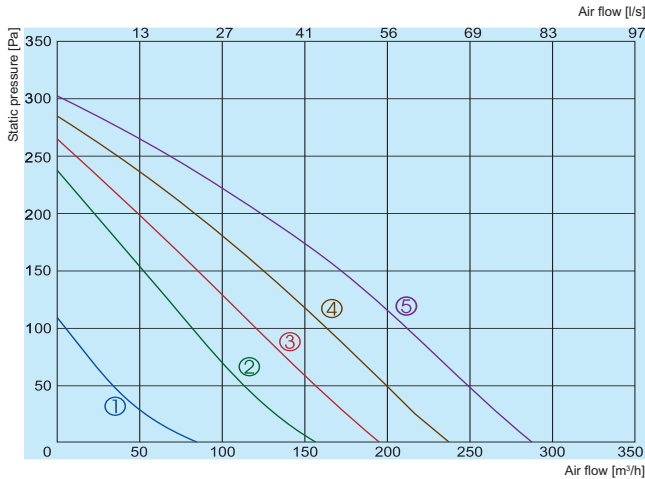

- ① 80V
- ② 120V
- ③ 140V
- ④ 170V
- ⑤ 230V

100 LD

In duct
Surrounding

LWA total, dB(A)	Lwa, dB(A)						
	125 Hz	250 Hz	500 Hz	1 kHz	2 kHz	4 kHz	8 kHz
In duct	70	53	60	60	67	65	48
Surrounding	58	33	26	43	55	54	36

Measured at 264 m³/h, 32 Pa

VKA 125 MD

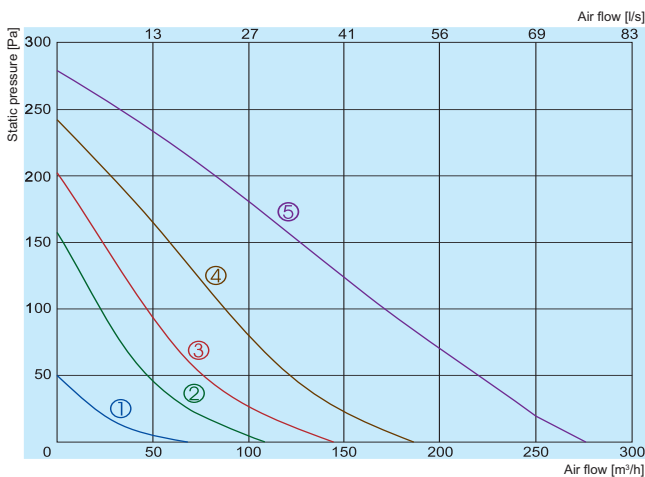

- ① 80V
- ② 120V
- ③ 140V
- ④ 170V
- ⑤ 230V

125 MD

In duct
Surrounding

LWA total, dB(A)	Lwa, dB(A)						
	125 Hz	250 Hz	500 Hz	1 kHz	2 kHz	4 kHz	8 kHz
In duct	59	42	54	52	53	52	39
Surrounding	44	20	29	35	41	40	28

Measured at 251 m³/h, 20 Pa

The fan characteristic curves were determined in accordance with EN ISO 5801. The sound levels were determined in accordance with DIN 45635 resp. ISO 3744 at a distance of 1 m from the fan.

VKA 125 LD

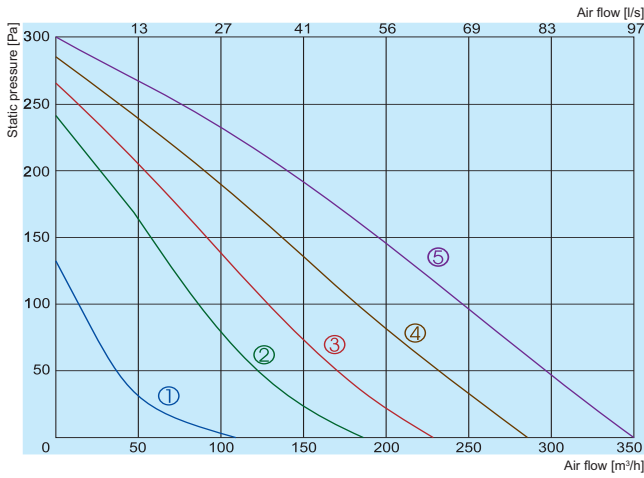

- ① 80V
- ② 120V
- ③ 140V
- ④ 170V
- ⑤ 230V

125 LD

In duct
Surrounding
Measured at 331 m³/h, 19 Pa

Lwa total, dB(A)	Lwa, dB(A)							
	125 Hz	250 Hz	500 Hz	1 kHz	2 kHz	4 kHz	8 kHz	
In duct	68	49	53	61	65	63	55	46
Surrounding	56	27	28	44	53	51	43	32

		100 MD	100 LD	125 MD	125 LD
Voltage/Frequency	[V/Hz]	230/50	230/50	230/50	230/50
Power consumption	[kW]	0,044	0,063	0,044	0,067
Current	[A]	0,19	0,27	0,19	0,29
Speed	[min ⁻¹]	1992	2478	1907	2514
Max. airflow	[m³/h]	232	290	278	350
Min./Max. air temperature	[°C]	-30/40	-30/70	-30/40	-30/70
Weight	[kg]	3	3	3	3
Wiring diagram		No. 2	No. 1	No. 2	No. 1
Protection class:	motor	IP-44	IP-44	IP-44	IP-44
	terminal box	IP-55	IP-55	IP-55	IP-55
Comply with ERP 2013/2015		+ \+	+ \+	+ \+	+ \+

VKA 150 LD

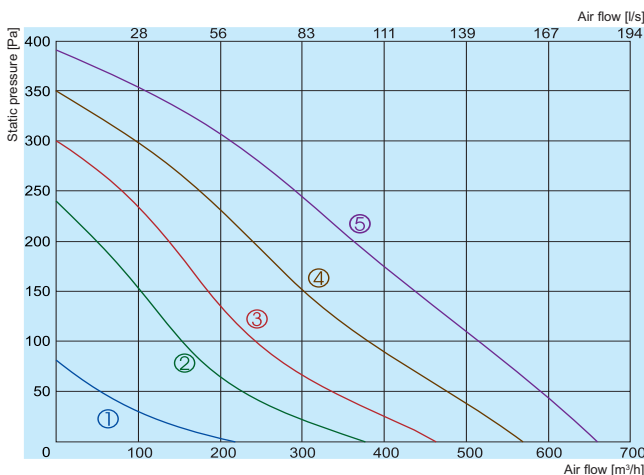

- ① 80V
- ② 120V
- ③ 140V
- ④ 170V
- ⑤ 230V

150 LD

In duct
Surrounding
Measured at 530 m³/h, 86 Pa

Lwa total, dB(A)	Lwa, dB(A)							
	125 Hz	250 Hz	500 Hz	1 kHz	2 kHz	4 kHz	8 kHz	
In duct	74	51	67	67	71	63	62	49
Surrounding	61	29	48	50	59	51	50	34

The fan characteristic curves were determined in accordance with EN ISO 5801. The sound levels were determined in accordance with DIN 45635 resp. ISO 3744 at a distance of 1 m from the fan.

VKA/VKAS

VKA 160 MD

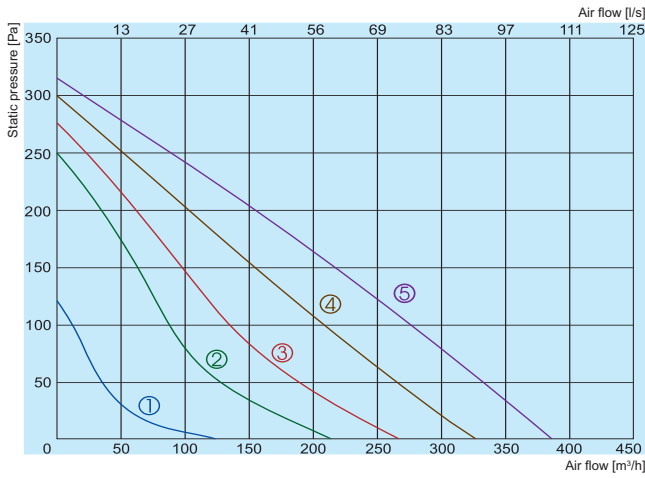

- ① 80V
- ② 120V
- ③ 140V
- ④ 170V
- ⑤ 230V

160 MD

In duct
Surrounding

LWA total, dB(A)	Lwa, dB(A)						
	125 Hz	250 Hz	500 Hz	1 kHz	2 kHz	4 kHz	8 kHz
In duct	68	47	50	56	64	63	49
Surrounding	56	25	20	39	52	51	34

Measured at 365 m³/h, 20 Pa

VKA 160 LD

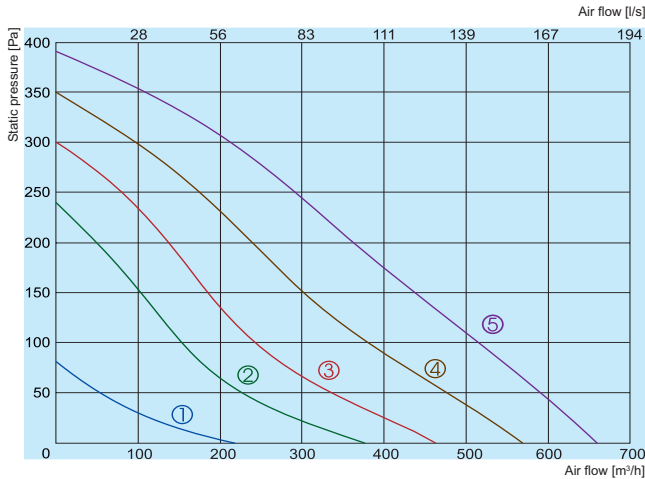

- ① 80V
- ② 120V
- ③ 140V
- ④ 170V
- ⑤ 230V

160 LD

In duct
Surrounding

LWA total, dB(A)	Lwa, dB(A)						
	125 Hz	250 Hz	500 Hz	1 kHz	2 kHz	4 kHz	8 kHz
In duct	74	51	67	67	71	63	49
Surrounding	61	29	48	50	59	51	34

Measured at 531 m³/h, 80 Pa

VKA 200 MD

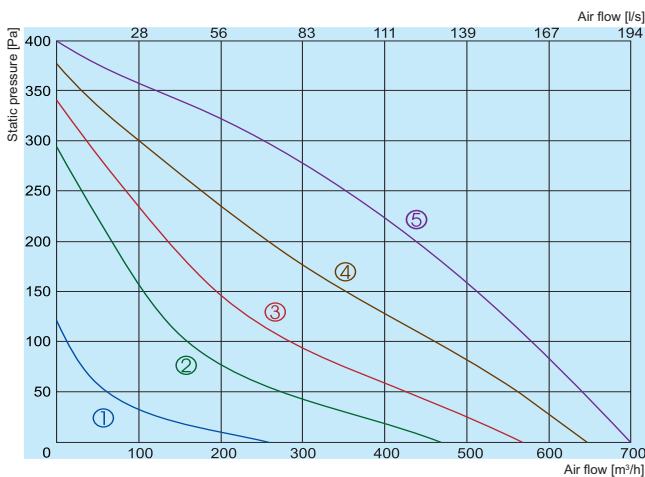

- ① 80V
- ② 120V
- ③ 140V
- ④ 170V
- ⑤ 230V

200 MD

In duct
Surrounding

LWA total, dB(A)	Lwa, dB(A)						
	125 Hz	250 Hz	500 Hz	1 kHz	2 kHz	4 kHz	8 kHz
In duct	70	44	53	60	67	64	52
Surrounding	55	14	23	40	49	42	38

Measured at 673 m³/h, 30 Pa

The fan characteristic curves were determined in accordance with EN ISO 5801. The sound levels were determined in accordance with DIN 45635 resp. ISO 3744 at a distance of 1 m from the fan.

VKA 200 LD

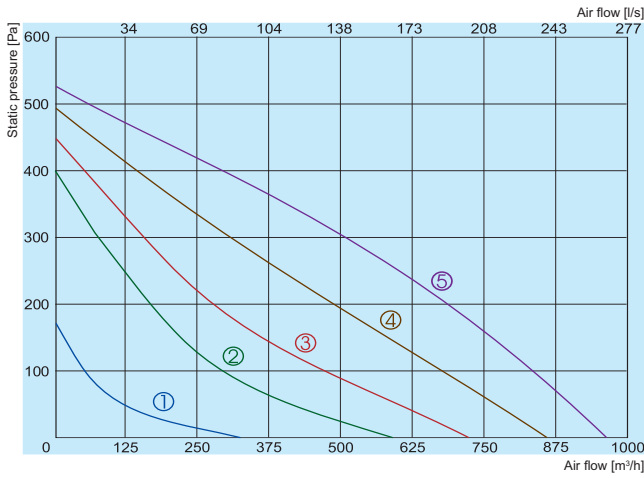

- ① 80V
- ② 120V
- ③ 140V
- ④ 170V
- ⑤ 230V

200 LD

In duct
Surrounding
Measured at 915 m³/h, 42 Pa

LWA total, dB(A)	Lwa, dB(A)						
	125 Hz	250 Hz	500 Hz	1 kHz	2 kHz	4 kHz	8 kHz
In duct	74	53	61	65	69	66	62
Surrounding	58	23	31	45	51	46	48

	150 LD	160 MD	160 LD	200 MD	200 LD
Voltage/Frequency	[V/Hz] 230/50	230/50	230/50	230/50	230/50
Power consumption	[kW] 0,100	0,065	0,100	0,100	0,140
Current	[A] 0,42	0,28	0,41	0,42	0,62
Speed	[min⁻¹] 2503	2409	2503	2503	2590
Max. airflow	[m³/h] 657	386	673	700	960
Min./Max. air temperature	[°C] -30/60	-30/70	-30/60	-30/60	-30/70
Weight	[kg] 4	3	4	4,5	5,0
Wiring diagram	No. 1	No. 1	No. 1	No. 1	No. 1
Protection class:	motor	IP-44	IP-44	IP-44	IP-44
	terminal box	IP-55	IP-55	IP-55	IP-55
Comply with ERP 2013/2015	+ \+	+ \+	+ \+	+ \+	- \-

VKA 250 MD

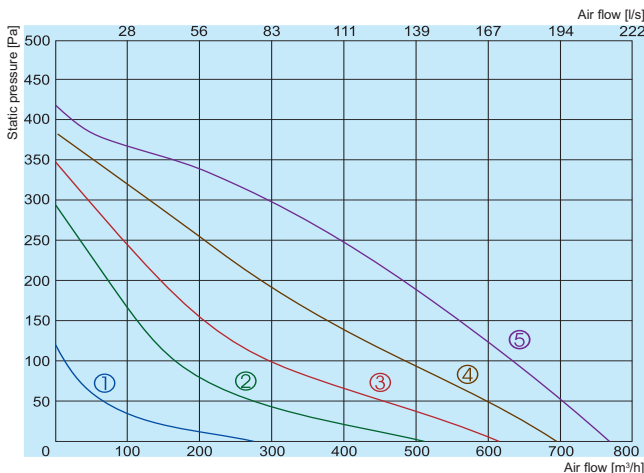

- ① 80V
- ② 120V
- ③ 140V
- ④ 170V
- ⑤ 230V

250 MD

In duct
Surrounding
Measured at 733 m³/h, 30 Pa

LWA total, dB(A)	Lwa, dB(A)						
	125 Hz	250 Hz	500 Hz	1 kHz	2 kHz	4 kHz	8 kHz
In duct	71	42	52	59	67	64	56
Surrounding	51	19	29	39	47	44	38

The fan characteristic curves were determined in accordance with EN ISO 5801. The sound levels were determined in accordance with DIN 45635 resp. ISO 3744 at a distance of 1 m from the fan.

VKA/VKAS

VKA 250 LD

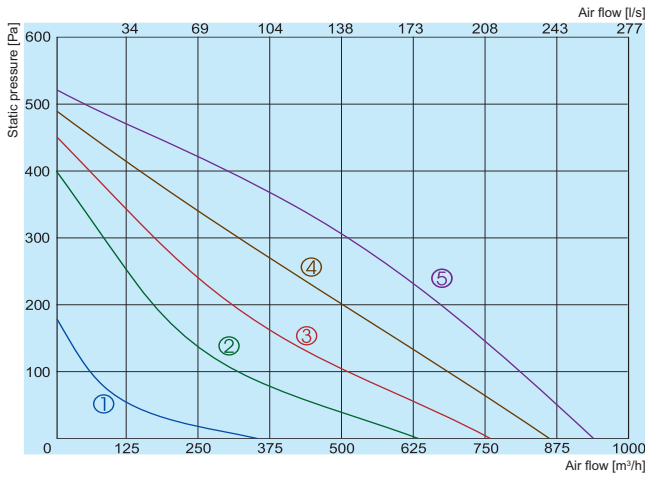

- ① 80V
- ② 120V
- ③ 140V
- ④ 170V
- ⑤ 230V

250 LD

In duct
Surrounding

LWA total, dB(A)	Lwa, dB(A)						
	125 Hz	250 Hz	500 Hz	1 kHz	2 kHz	4 kHz	8 kHz
In duct	74	54	62	66	69	67	66
Surrounding	55	31	39	46	49	47	48

Measured at 893 m³/h, 39 Pa

VKA 315 MD

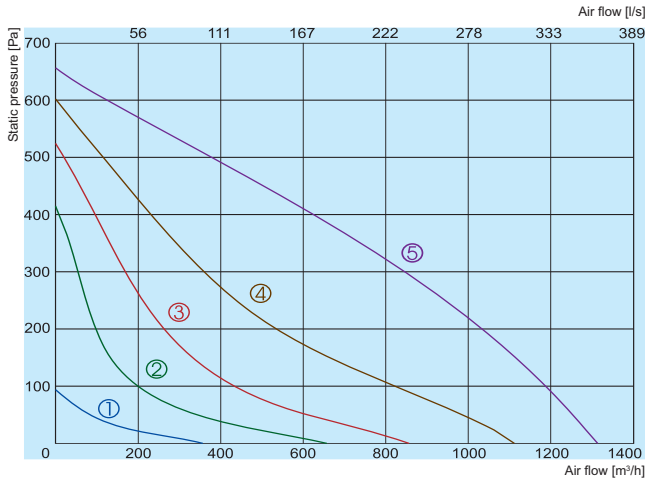

- ① 80V
- ② 120V
- ③ 140V
- ④ 170V
- ⑤ 230V

315 MD

In duct
Surrounding

LWA total, dB(A)	Lwa, dB(A)						
	125 Hz	250 Hz	500 Hz	1 kHz	2 kHz	4 kHz	8 kHz
In duct	78	53	62	70	75	68	68
Surrounding	57	32	40	49	54	49	44

Measured at 1195 m³/h, 100 Pa

VKA 315 LD

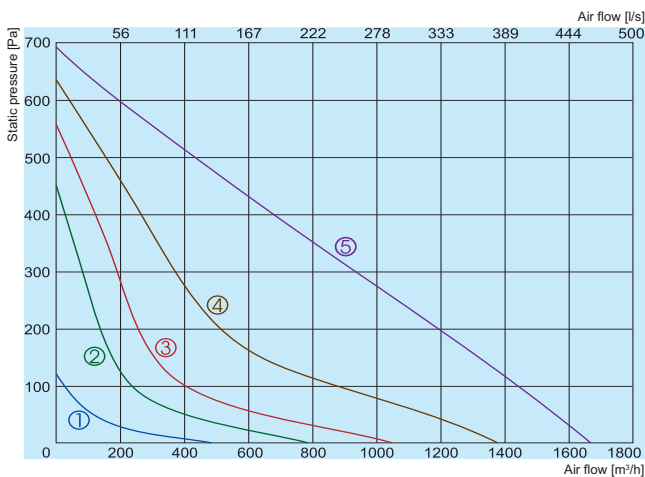

- ① 80V
- ② 120V
- ③ 140V
- ④ 170V
- ⑤ 230V

315 LD

In duct
Surrounding

LWA total, dB(A)	Lwa, dB(A)						
	125 Hz	250 Hz	500 Hz	1 kHz	2 kHz	4 kHz	8 kHz
In duct	75	51	61	67	67	68	69
Surrounding	54	30	39	46	46	49	45

Measured at 1583 m³/h, 43 Pa

The fan characteristic curves were determined in accordance with EN ISO 5801. The sound levels were determined in accordance with DIN 45635 resp. ISO 3744 at a distance of 1 m from the fan.

		250 MD	250 LD	315 MD	315 LD
Voltage/Frequency	[V/Hz]	230/50	230/50	230/50	230/50
Power consumption	[kW]	0,100	0,136	0,214	0,292
Current	[A]	0,43	0,6	0,96	1,27
Speed	[min ⁻¹]	2505	2590	2500	2266
Max. airflow	[m ³ /h]	760	938	1310	1670
Min./Max. air temperature	[°C]	-30/60	-30/70	-25/70	-30/45
Weight	[kg]	4,5	4,5	6,5	6,5
Wiring diagram		No. 1	No. 1	No. 3	No. 1
Protection class:	motor	IP-44	IP-44	IP-44	IP-44
	terminal box	IP-55	IP-55	IP-55	IP-55
Comply with ERP 2013/2015		++	-/-	-/-	-/-

VKAS 100 MD

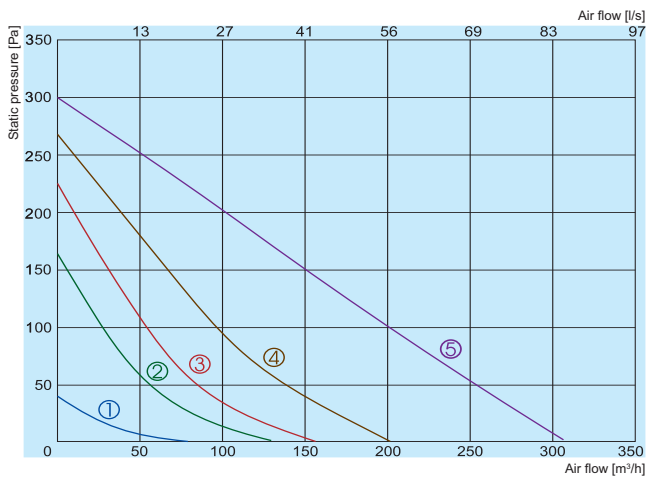

- ① 80V
- ② 120V
- ③ 140V
- ④ 170V
- ⑤ 230V

100 MD

In duct
Surrounding

Measured at 253 m³/h, 45 Pa

Lwa total, dB(A)	Lwa, dB(A)						
	125 Hz	250 Hz	500 Hz	1 kHz	2 kHz	4 kHz	8 kHz
In duct	61	43	58	51	55	50	39
Surrounding	46	24	25	35	44	41	28

VKAS 100 LD

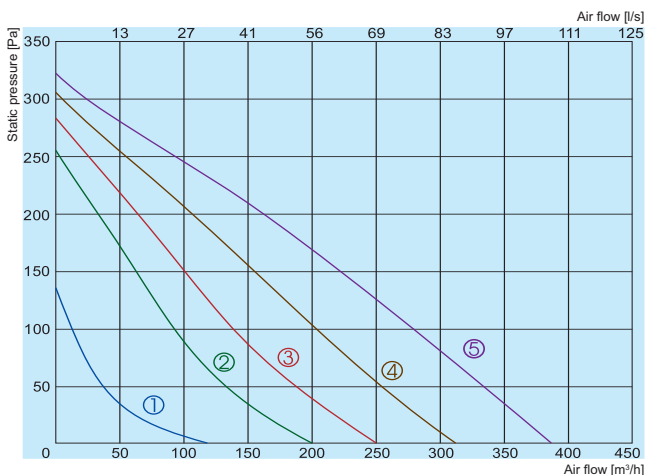

- ① 80V
- ② 120V
- ③ 140V
- ④ 170V
- ⑤ 230V

100 LD

In duct
Surrounding

Measured at 325 m³/h, 61 Pa

Lwa total, dB(A)	Lwa, dB(A)						
	125 Hz	250 Hz	500 Hz	1 kHz	2 kHz	4 kHz	8 kHz
In duct	70	53	60	60	67	65	48
Surrounding	58	33	26	43	55	54	36

The fan characteristic curves were determined in accordance with EN ISO 5801. The sound levels were determined in accordance with DIN 45635 resp. ISO 3744 at a distance of 1 m from the fan.

VKAS 125 MD

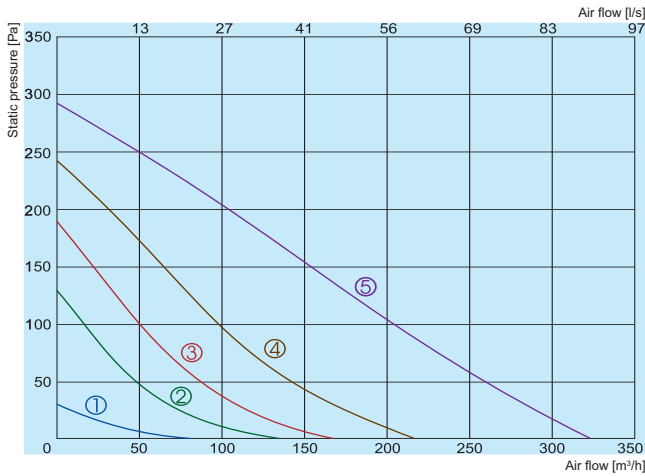

- ① 80V
- ② 120V
- ③ 140V
- ④ 170V
- ⑤ 230V

125 MD

In duct
Surrounding

LWA total, dB(A)	Lwa, dB(A)						
	125 Hz	250 Hz	500 Hz	1 kHz	2 kHz	4 kHz	8 kHz
In duct	59	42	54	52	53	52	39
Surrounding	44	20	29	35	41	40	28

Measured at 262 m³/h, 46 Pa

VKAS 125 LD

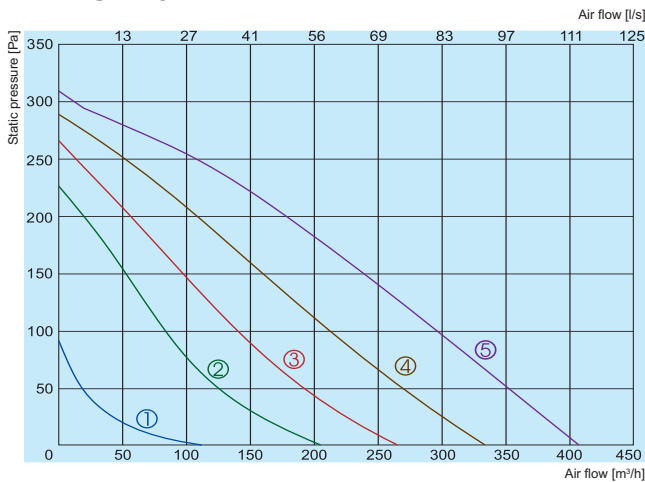

- ① 80V
- ② 120V
- ③ 140V
- ④ 170V
- ⑤ 230V

125 LD

In duct
Surrounding

LWA total, dB(A)	Lwa, dB(A)						
	125 Hz	250 Hz	500 Hz	1 kHz	2 kHz	4 kHz	8 kHz
In duct	68	49	53	61	65	63	55
Surrounding	56	27	28	44	53	51	43

Measured at 362 m³/h, 41 Pa

		100 MD	100 LD	125 MD	125 LD
Voltage/Frequency	[V/Hz]	230/50	230/50	230/50	230/50
Power consumption	[kW]	0,045	0,064	0,045	0,066
Current	[A]	0,2	0,28	0,2	0,29
Speed	[min ⁻¹]	1992	2478	1907	2514
Max. airflow	[m³/h]	300	380	324	400
Min./Max. air temperature	[°C]	-30/40	-30/70	-30/40	-30/70
Weight	[kg]	2,5	2,5	2,5	2,5
Wiring diagram		No. 2	No. 1	No. 2	No. 1
Protection class:	motor	IP-44	IP-44	IP-44	IP-44
	terminal box	IP-55	IP-55	IP-55	IP-55
Comply with ERP 2013/2015		+ \+	+ \+	+ \+	+ \+

The fan characteristic curves were determined in accordance with EN ISO 5801. The sound levels were determined in accordance with DIN 45635 resp. ISO 3744 at a distance of 1 m from the fan.

VKAS 150 LD

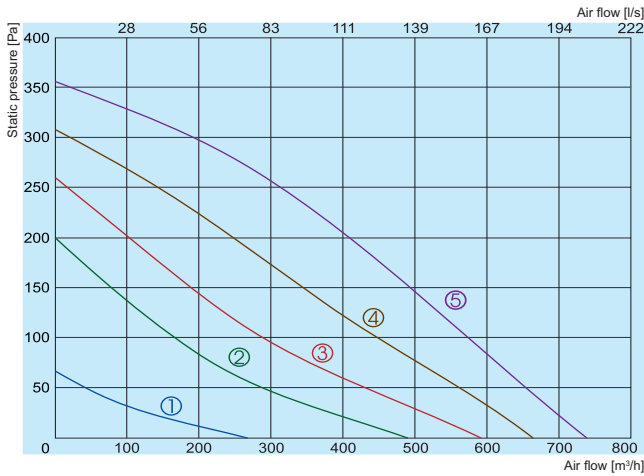

- ① 80V
- ② 120V
- ③ 140V
- ④ 170V
- ⑤ 230V

150LD

In duct
Surrounding

Lwa total, dB(A)	Lwa, dB(A)						
	125 Hz	250 Hz	500 Hz	1 kHz	2 kHz	4 kHz	8 kHz
In duct	74	51	67	67	71	63	49
Surrounding	61	29	48	50	59	51	34

Measured at 600 m³/h, 81 Pa

VKAS 160 MD

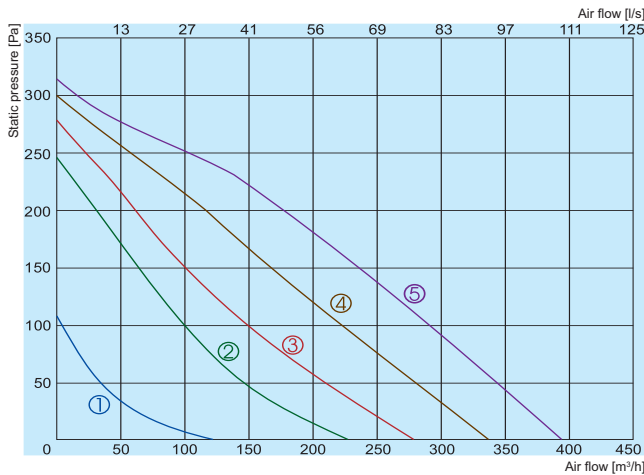

- ① 80V
- ② 120V
- ③ 140V
- ④ 170V
- ⑤ 230V

160 MD

In duct
Surrounding

Lwa total, dB(A)	Lwa, dB(A)						
	125 Hz	250 Hz	500 Hz	1 kHz	2 kHz	4 kHz	8 kHz
In duct	68	47	50	56	64	62	49
Surrounding	56	25	20	39	52	50	34

Measured at 355 m³/h, 40 Pa

VKAS 160 LD

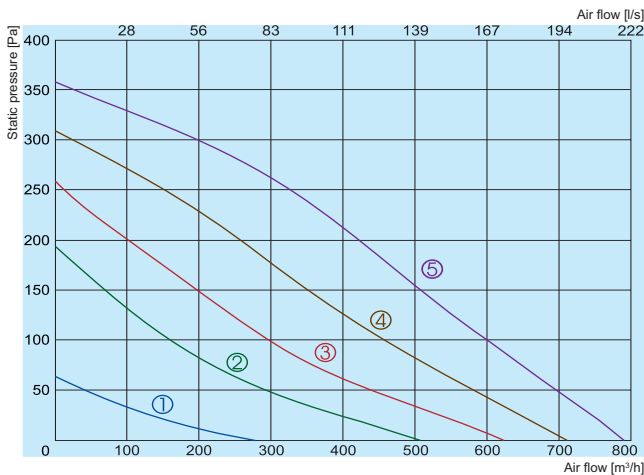

- ① 80V
- ② 120V
- ③ 140V
- ④ 170V
- ⑤ 230V

160LD

In duct
Surrounding

Lwa total, dB(A)	Lwa, dB(A)						
	125 Hz	250 Hz	500 Hz	1 kHz	2 kHz	4 kHz	8 kHz
In duct	74	51	67	67	71	62	49
Surrounding	61	29	48	50	59	51	34

Measured at 599 m³/h, 101 Pa

The fan characteristic curves were determined in accordance with EN ISO 5801. The sound levels were determined in accordance with DIN 45635 resp. ISO 3744 at a distance of 1 m from the fan.

VKAS 200 MD

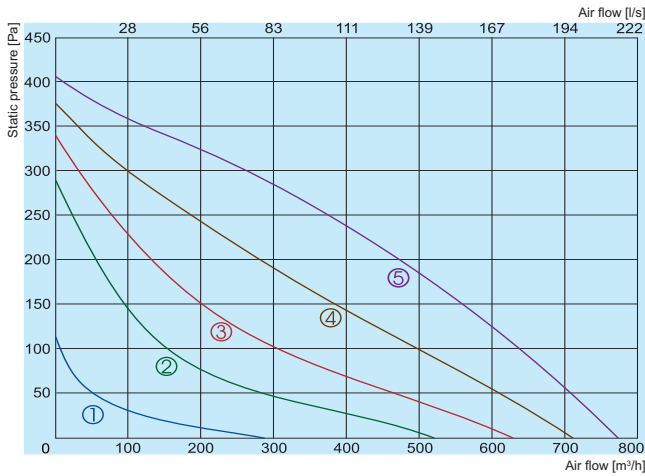

- ① 80V
- ② 120V
- ③ 140V
- ④ 170V
- ⑤ 230V

200 MD

In duct
Surrounding

LWA total, dB(A)	Lwa, dB(A)						
	125 Hz	250 Hz	500 Hz	1 kHz	2 kHz	4 kHz	8 kHz
In duct	70	44	53	60	67	62	52
Surrounding	55	14	23	40	49	42	38

Measured at 670 m³/h, 80 Pa

VKAS 200 LD

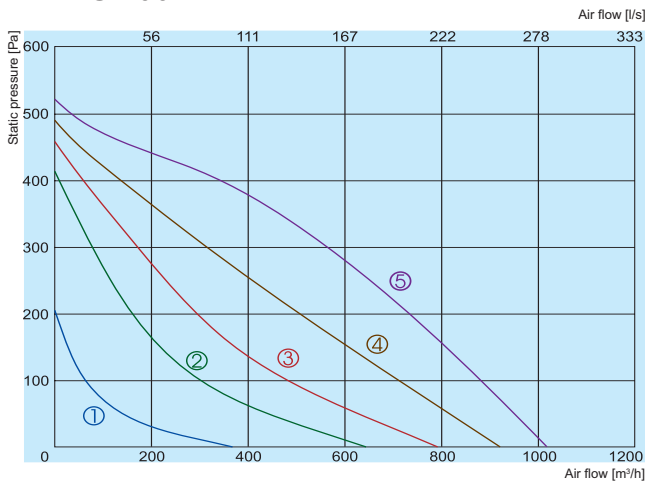

- ① 80V
- ② 120V
- ③ 140V
- ④ 170V
- ⑤ 230V

200 LD

In duct
Surrounding

LWA total, dB(A)	Lwa, dB(A)						
	125 Hz	250 Hz	500 Hz	1 kHz	2 kHz	4 kHz	8 kHz
In duct	74	53	61	65	69	66	62
Surrounding	58	23	31	45	51	46	48

Measured at 956 m³/h, 46 Pa

		150 LD	160 MD	160 LD	200 MD	200 LD
Voltage/Frequency	[V/Hz]	230/50	230/50	230/50	230/50	230/50
Power consumption	[kW]	0,092	0,064	0,095	0,097	0,140
Current	[A]	0,40	0,28	0,41	0,42	0,62
Speed	[min ⁻¹]	2503	2409	2503	2503	2590
Max. airflow	[m³/h]	730	395	794	775	1000
Min./Max. air temperature	[°C]	-30/60	-30/70	-30/60	-30/60	-30/70
Weight	[kg]	4	2,8	4	4,1	4,8
Wiring diagram		No. 1	No. 1	No. 1	No. 1	No. 1
Protection class:	motor	IP-44	IP-44	IP-44	IP-44	IP-44
	terminal box	IP-55	IP-55	IP-55	IP-55	IP-55
Comply with ERP 2013/2015		+ +	+ +	+ +	+ +	- -

The fan characteristic curves were determined in accordance with EN ISO 5801. The sound levels were determined in accordance with DIN 45635 resp. ISO 3744 at a distance of 1 m from the fan.

VKAS 250 MD

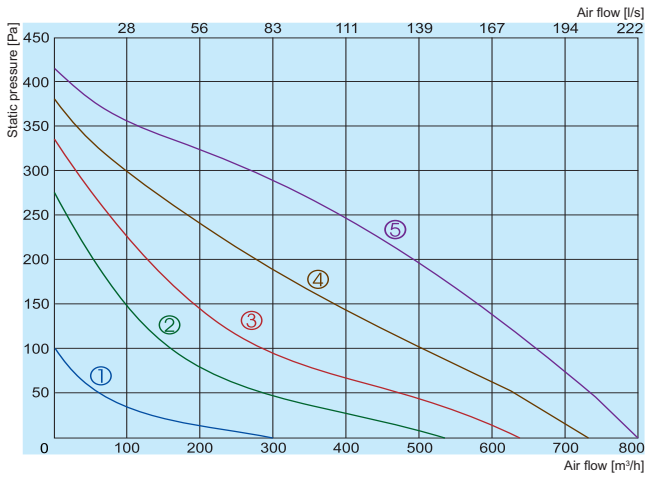

- ① 80V
- ② 120V
- ③ 140V
- ④ 170V
- ⑤ 230V

250 MD

In duct
Surrounding

LWA total, dB(A)	Lwa, dB(A)						
	125 Hz	250 Hz	500 Hz	1 kHz	2 kHz	4 kHz	8 kHz
In duct	71	42	52	59	67	64	66
Surrounding	51	19	29	39	47	44	38

Measured at 763 m³/h, 31 Pa

VKAS 250 LD

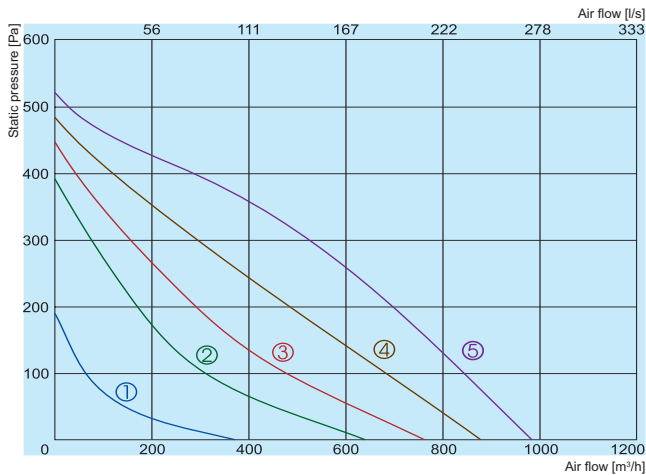

- ① 80V
- ② 120V
- ③ 140V
- ④ 170V
- ⑤ 230V

250 LD

In duct
Surrounding

LWA total, dB(A)	Lwa, dB(A)						
	125 Hz	250 Hz	500 Hz	1 kHz	2 kHz	4 kHz	8 kHz
In duct	74	54	62	66	69	67	66
Surrounding	55	31	39	46	49	47	48

Measured at 926 m³/h, 40 Pa

VKAS 315 MD

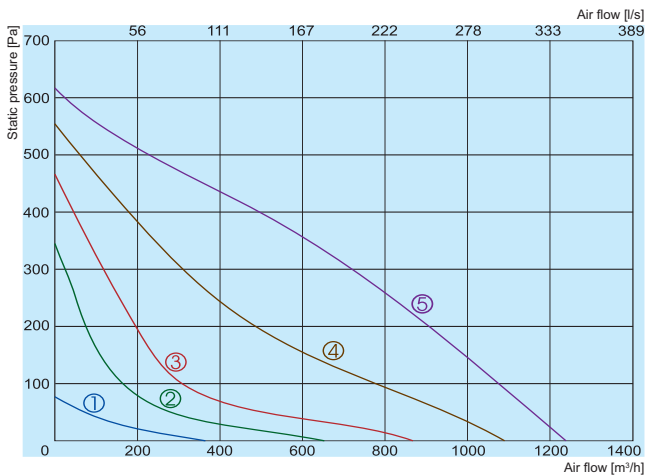

- ① 80V
- ② 120V
- ③ 140V
- ④ 170V
- ⑤ 230V

315 MD

In duct
Surrounding

LWA total, dB(A)	Lwa, dB(A)						
	125 Hz	250 Hz	500 Hz	1 kHz	2 kHz	4 kHz	8 kHz
In duct	78	53	62	70	75	68	68
Surrounding	57	32	40	49	54	49	44

Measured at 1257 m³/h, 50 Pa

The fan characteristic curves were determined in accordance with EN ISO 5801. The sound levels were determined in accordance with DIN 45635 resp. ISO 3744 at a distance of 1 m from the fan.

The company reserves the right to make changes of technical data without prior notice

VKAS 315 LD

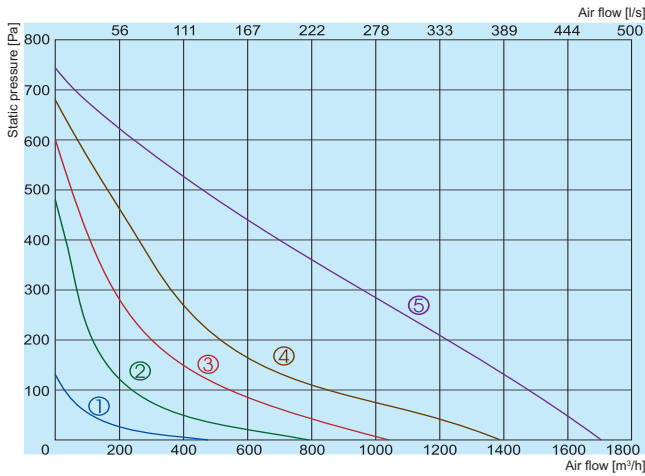

- ① 80V
- ② 120V
- ③ 140V
- ④ 170V
- ⑤ 230V

315 LD

In duct
Surrounding

Lwa total, dB(A)	Lwa, dB(A)						
	125 Hz	250 Hz	500 Hz	1 kHz	2 kHz	4 kHz	8 kHz
In duct	75	51	61	67	67	68	69
Surrounding	54	30	39	46	46	49	45

Measured at 1595 m³/h, 49 Pa

		250 MD	250 LD	315 MD	315 LD
Voltage/Frequency	[V/Hz]	230/50	230/50	230/50	230/50
Power consumption	[kW]	0,099	0,136	0,214	0,303
Current	[A]	0,43	0,6	0,96	1,33
Speed	[min ⁻¹]	2505	2590	2500	2266
Max. airflow	[m³/h]	800	960	1310	1670
Min./Max. air temperature	[°C]	-30/70	-30/70	-25/70	-30/45
Weight	[kg]	4,1	4,9	5,6	6,0
Wiring diagram		No. 1	No. 1	No. 3	No. 1
Protection class:	motor	IP-44	IP-44	IP-44	IP-44
	terminal box	IP-55	IP-55	IP-55	IP-55
Comply with ERP 2013/2015		+ +	- -	- -	- -

Wiring diagram No. 1 (1~230V)

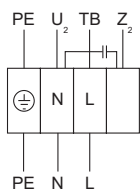

U₂ - blue or grey
Z₂ - black
TB - brown
PE - green - yellow

Wiring diagram No. 2 (1~230V)

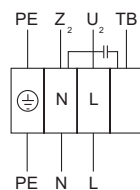

U₂ - blue or grey
Z₂ - black
TB - brown
PE - green - yellow

Wiring diagram No. 3 (1~230V)

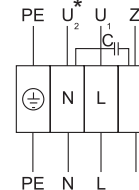

U₁ - blue
U₂* - black
Z - brown
PE - green - yellow