



Air handling units

Oro tiekimo agrgatai

Centrale klimatyzacyjne

Приточные агрегаты



- Low noise level.
- Fans: ~1f with external rotor motor.
- Adjustable voltage fan control.
- Electrical heater.
- Easily removable inspection cover.
- Filter box with an G4-class panel filter.
- Wall insulation is 50mm.

Air supply units for ventilation systems. Not designed for functioning in explosive – inclined areas. The unit is designed for the air supply into premises. It consists of a duct fan, a duct air heater and a filter box. All these elements are installed in an isolated housing. The thickness of the wall insulation is 50 mm. The housing is made of galvanized steel and has an easily removable cover. The cover is attached by four hinges which are easy to unclasp.



- Žemas triukšmo lygis
- Reguliuojamo greičio ventiliatorius (įtampos keitimas)
- Elektrinis šildytuvas
- Lengvai nuimamas dangtis patikrinimui
- Filtrų dėžė su G4 klasės filtru

Oro tiekimo agregatas skirtas oro tiekimui į patalpas. Jis susideda iš kanalinio ventiliatoriaus, kanalinio oro šildytuvo ir filtrų dėžės. Visi šie elementai sumontuoti izoliuotame korpuse. Izoliacijos storis 50 mm. Korpusas pagamintas iš cinkuotos skardos su lengvai nuimamu dangčiu. Dangtis tvirtinamas keturiais lengvai atsegamais lankstais.



- Niski poziom hałasu.
- Wentylatory: ~ 1f z zewnętrznym wirnikiem.
- Regulacja wentylatora napięcia.
- Nagrzewnica elektryczna.
- Łatwo zdejmowana pokrywa inspekcji.
- Filtr pole z klasy G4 filtru panelu.
- Izolacja ścian 50mm.

Jednostki nawiewne dla systemów wentylacyjnych. Nie jest przeznaczony do funkcjonowania w wybuchowych - pochyłe powierzchnie. Urządzenie przeznaczone jest do powietrza dostarczyć do pomieszczeń. Składa się on z przewodu wentylator, nagrzewnica kanałowa powietrza i filter box. Wszystkie te elementy są zamontowane w obudowie pojedyncze. Grubość izolacji ściany wynosi 50 mm. Obudowa wykonana jest z ocynkowanej blachy stalowej i posiada łatwo zdejmowaną pokrywę. Pokrywa jest dołączona przez czterech zawiasach, które łatwo odpiąć.



- Низкий уровень шума.
- Вентилятор с регулировкой скорости (изменение напряжения).
- Электрический нагреватель.
- Легко снимаемая крышка для проверки.
- Кассета фильтров с фильтром класса G4.

Агрегат подачи воздуха предназначен для подачи воздуха в помещения. Он состоит из канального вентилятора, канального нагревателя воздуха и кассеты фильтров. Все эти элементы установлены в изолированном корпусе. Толщина изоляции 50 мм. Корпус изготовлен из оцинкованной жести с легко снимаемой крышкой. Крышка крепится легко отстегивающимися шарнирами.

## Accessories

Single phase speed controller	Monophase speed controller	Controller for electrical heater	Controller for electrical heater	Mounting clamp	Back draft shutter
TGRV p. 223	ETY p.225	EKR 15.1 p. 220	EKR 6.1 p. 222	AP p. 229	RSK p. 227

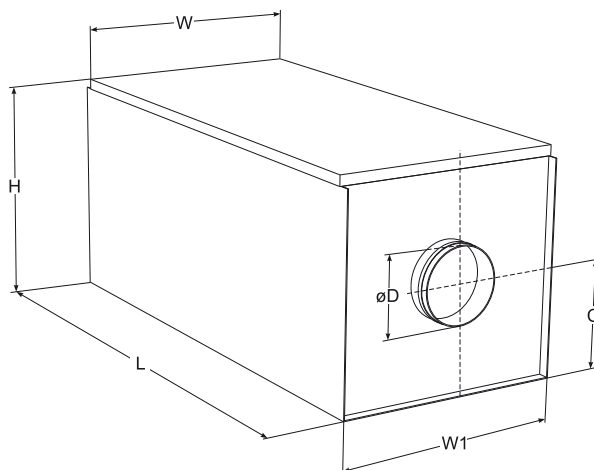

Type	Dimensions [mm]					
	W	W1	C	L	H	øD
OTA 125	490	485	236	1000	490	125
OTA 160	490	485	236	1000	490	160
OTA 200	490	485	236	1000	490	200
OTA 250	550	545	285	1050	585	250
OTA 315	550	545	285	1050	585	315

Type	Accessories							
	TGRV	ETY	EKR 15.1	EKR 6.1	AP	RSK	AKS	TJK 10K
OTA 125/1200	1	1,5	-	+	125	125	125	+
OTA 160/2000	1	1,5	-	+	160	160	160	+
OTA 160/2400	1	1,5	-	+	160	160	160	+
OTA 160/5000	1	1,5	-	+	160	160	160	+
OTA 160/6000	1	1,5	-	+	160	160	160	+
OTA 200/2000	1	1,5	-	+	200	200	200	+
OTA 200/2400	1	1,5	-	+	200	200	200	+
OTA 200/3000	1	1,5	-	+	200	200	200	+
OTA 200/5000	1	1,5	-	+	200	200	200	+
OTA 200/6000	1	1,5	-	+	200	200	200	+
OTA 250/1200	1	1,5	-	+	250	250	250	+
OTA 250/5000	1	1,5	-	+	250	250	250	+
OTA 250/6000	1	1,5	-	+	250	250	250	+
OTA 250/9000	1	1,5	+	-	250	250	250	+
OTA 315/5000	2	2,5	-	+	315	315	315	+
OTA 315/6000	2	2,5	-	+	315	315	315	+
OTA 315/9000	2	2,5	+	-	315	315	315	+

## Accessories

Circular duct silencer



AKS p. 230

Duct sensor



TJK 10K p. 187

# OTA

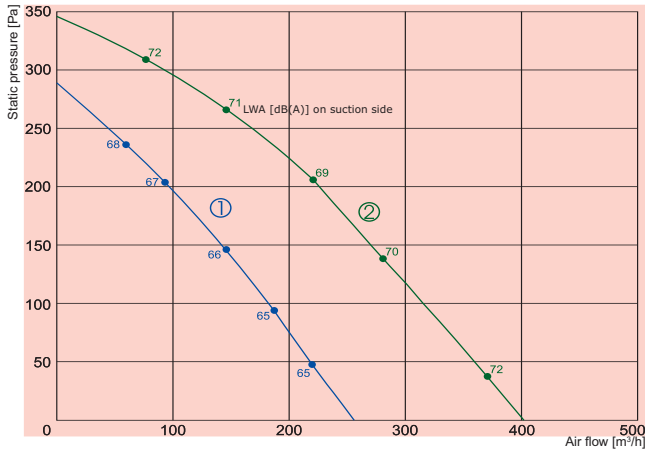

① — OTA 125  
② — OTA 160

		125/1200	160/2000	160/2400	160/5000	160/6000
Heater	-phase/voltage [50Hz/VAC]	~1, 230	~1, 230	~1, 230	~2, 400	~2, 400
	-power consumption [kW]	1,2	2,0	2,4	5,0	6,0
	-min. air speed [m/s]	1,5	1,5	1,5	1,5	1,5
Fan	-phase/voltage [50Hz/VAC]	~1, 230	~1, 230	~1, 230	~1, 230	~1, 230
	-current [A]	0,26	0,41	0,41	0,41	0,41
	-speed [min <sup>-1</sup> ]	2549	2621	2621	2621	2621
	-power consumption [W]	60	95	95	95	95
	-max. airflow [m³/h]	256	402	402	402	402
-motor protection class	IP-44	IP-44	IP-44	IP-44	IP-44	
Terminal box protection class	IP-54	IP-54	IP-54	IP-54	IP-54	
Filter class	G4	G4	G4	G4	G4	
Total sound pressure level at 1 m [dBA]	58	63	63	63	63	
Wiring diagram	No. 1	No. 1	No. 1	No. 2	No. 2	
Weight [kg]	37,0	39,0	40,5	41,0	39,0	

OTA 125	Lwa total, dB(A)	LWA, dB(A)						
		125 Hz	250 Hz	500 Hz	1 kHz	2 kHz	4 kHz	8 kHz
Inlet	65	38	59	58	60	59	52	42
Outlet	63	38	57	55	58	56	46	38
Surrounding	48	23	42	41	42	41	35	27

Measured at 202 m³/h, 72 Pa

OTA 160	Lwa total, dB(A)	LWA, dB(A)						
		125 Hz	250 Hz	500 Hz	1 kHz	2 kHz	4 kHz	8 kHz
Inlet	70	43	65	60	65	63	57	43
Outlet	70	47	63	64	64	61	55	44
Surrounding	52	28	48	43	47	45	40	28

Measured at 281 m³/h, 138Pa

The unit characteristic curves were determined in accordance with DIN 24163 resp. ISO 5801. The sound levels were determined in accordance with DIN 45635 resp. ISO 3744 at a distance of 1 m from the unit.

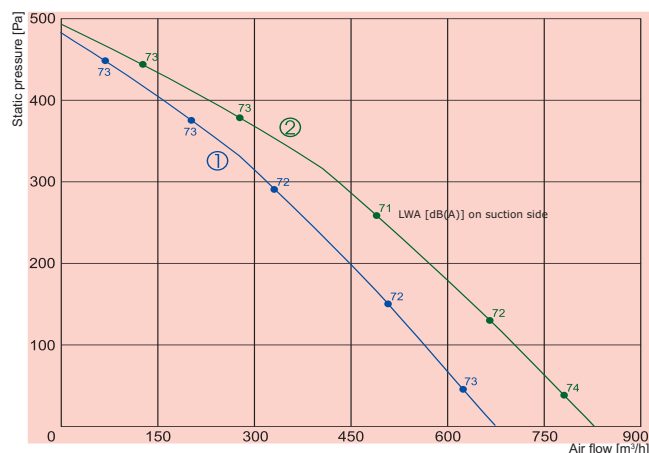

① OTA 200  
② OTA 250

		200/2000	200/2400	200/3000	200/5000	200/6000
Heater	-phase/voltage [50Hz/VAC]	~1, 230	~1, 230	~2, 400	~2, 400	~2, 400
	-power consumption [kW]	2,0	2,4	3,0	5,0	6,0
	-min. air speed [m/s]	1,5	1,5	1,5	1,5	1,5
Fan	-phase/voltage [50Hz/VAC]	~1, 230	~1, 230	~1, 230	~1, 230	~1, 230
	-current [A]	0,72	0,72	0,72	0,72	0,72
	-speed [min <sup>-1</sup> ]	2621	2621	2621	2621	2621
	-power consumption [W]	164	164	164	164	164
	-max. airflow [m³/h]	675	675	675	675	675
-motor protection class		IP-44	IP-44	IP-44	IP-44	IP-44
Terminal box protection class		IP-54	IP-54	IP-54	IP-54	IP-54
Filter class		G4	G4	G4	G4	G4
Total sound pressure level at 1 m [dBA]		65	65	65	65	65
Wiring diagram		No. 1	No. 1	No. 2	No. 2	No. 2
41,0Weight [kg]		43,0	43,0	42,5	43,0	44,0

		250/1200	250/5000	250/6000	250/9000
Heater	-phase/voltage [50Hz/VAC]	~1, 230	~2, 400	~2, 400	~3, 400
	-power consumption [kW]	1,0	5,0	6,0	9,0
	-min. air speed [m/s]	1,5	1,5	1,5	1,5
Fan	-phase/voltage [50Hz/VAC]	~1, 230	~1, 230	~1, 230	~1, 230
	-current [A]	0,71	0,71	0,71	0,71
	-speed [min <sup>-1</sup> ]	2497	2497	2497	2497
	-power consumption [W]	160	160	160	160
	-max. airflow [m³/h]	828	828	828	828
-motor protection class		IP-44	IP-44	IP-44	IP-44
Terminal box protection class		IP-54	IP-54	IP-54	IP-54
Filter class		G4	G4	G4	G4
Total sound pressure level at 1 m [dBA]		65	65	65	65
Wiring diagram		No. 1	No. 2	No. 2	No. 3
Weight [kg]		51,0	51,0	51,0	51,0

OTA 200	Lwa total, dB(A)	LWA, dB(A)							
		125 Hz	250 Hz	500 Hz	1 kHz	2 kHz	4 kHz	8 kHz	
Inlet	72	54	65	62	67	66	64	54	
Outlet	71	47	66	65	65	62	56	44	
Surrounding	55	39	48	45	49	48	47	39	
Measured at 565 m³/h, 100 Pa									

OTA 250	Lwa total, dB(A)	LWA, dB(A)							
		125 Hz	250 Hz	500 Hz	1 kHz	2 kHz	4 kHz	8 kHz	
Inlet	72	53	64	61	67	67	64	55	
Outlet	70	55	64	63	63	62	61	55	
Surrounding	56	38	47	45	51	50	48	40	
Measured at 666 m³/h, 130 Pa									

The unit characteristic curves were determined in accordance with DIN 24163 resp. ISO 5801. The sound levels were determined in accordance with DIN 45635 resp. ISO 3744 at a distance of 1 m from the unit.

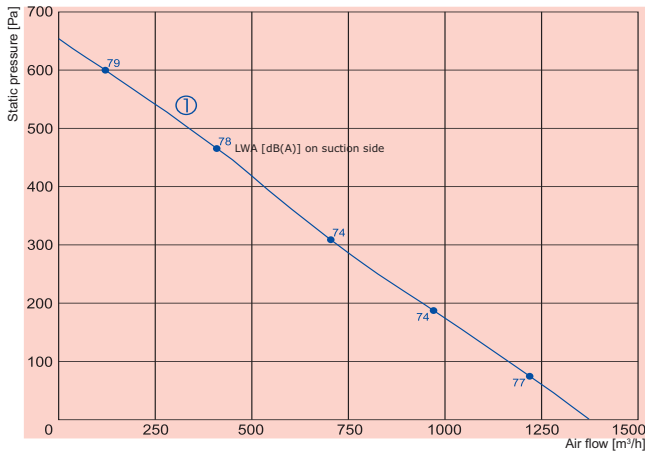

		315/5000	315/6000	315/9000
Heater	-phase/voltage [50Hz/VAC]	~2, 400	~2, 400	~3, 400
	-power consumption [kW]	5,0	6,0	9,0
	-min. air speed [m/s]	1,5	1,5	1,5
Fan	-phase/voltage [50Hz/VAC]	~1, 230	~1, 230	~1, 230
	-current [A]	1,29	1,29	1,29
	-speed [min <sup>-1</sup> ]	2343	2343	2343
	-power consumption [W]	297	297	297
	-max. airflow [m³/h]	1373	1373	1373
	-motor protection class	IP-44	IP-44	IP-44
Terminal box protection class		IP-54	IP-54	IP-54
Filter class		G4	G4	G4
Total sound pressure level at 1 m [dBA]		68	68	68
Wiring diagram		No. 2	No. 2	No. 3
Weight [kg]		51,0	55,5	57,0

OTA 315	Lwa total, dB(A)	LWA, dB(A)						
		125 Hz	250 Hz	500 Hz	1 kHz	2 kHz	4 kHz	8 kHz
Inlet	75	54	62	62	70	72	66	60
Outlet	72	59	61	65	64	66	63	59
Surrounding	58	39	45	45	54	54	50	45

Measured at 1062 m³/h, 148Pa

The unit characteristic curves were determined in accordance with DIN 24163 resp. ISO 5801. The sound levels were determined in accordance with DIN 45635 resp. ISO 3744 at a distance of 1 m from the unit.

OTA versions with electrical heater

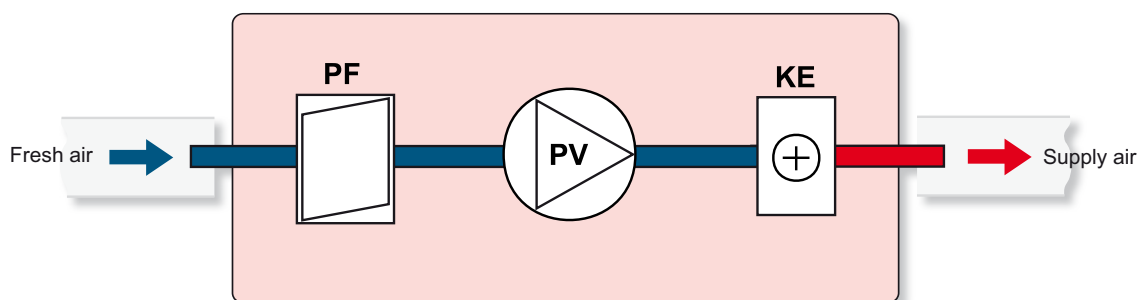

- PV - supply air fan
- KE - electrical heater
- PF - filter for supply air (class G4)

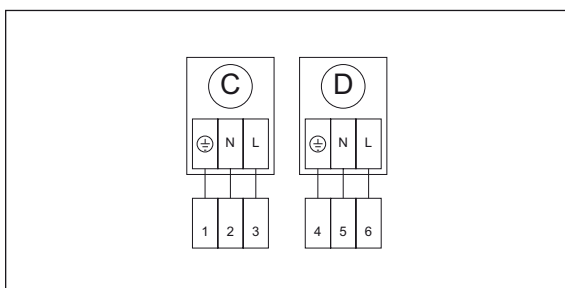

Wiring diagram No. 1

- C - Circular fan
- D - Electrical heater

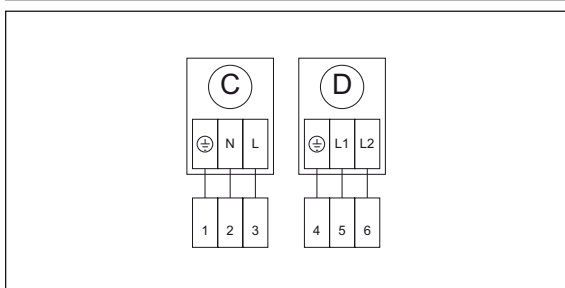

Wiring diagram No. 2

- C - Circular fan
- D - Electrical heater

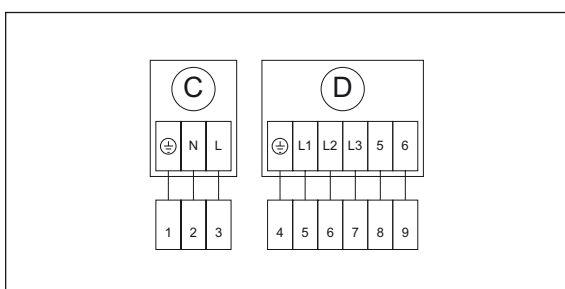

Wiring diagram No. 3

- C - Circular fan
- D - Electrical heater